

Technical Manual
WHOLEHOUSE WATER FILTER



Models: **IQ-WHF-**

TABLE OF CONTENT

Table of content.....	Page 2
Warning & Safety instructions.....	Page 3
Operating conditions & Requirements	Page 4
Installation	Page 5
Commissioning.....	Page 6
Electronic control panel	Page 7
Maintenance.....	Page 11
Troubleshooting.....	Page 12
Electrical wiring diagram	Page 13
Default configuration parameter settings.....	Page 14
Exploded view - System.....	Page 15
Exploded view - Timer assembly	Page 17
Exploded view - Valve body.....	Page 19
Technical data	Page 21

WARNING & SAFETY INSTRUCTIONS

- Before you begin the installation of the appliance, we advise you read and carefully follow the instructions contained in this manual. It contains important information about safety, installation, use and maintenance of the product. The actual system that you have received, may differ from the pictures/illustrations/descriptions in this Technical Manual.
- Failure to follow the instructions could cause personal injury or damage to the appliance or property. Only when installed, commissioned and serviced correctly, the appliance will offer you many years of trouble-free operation.
- The appliance is intended to 'filter' the water, meaning it will remove specific undesired substances; it will not necessarily remove other contaminants present in the water. The appliance will not purify polluted water or make it safe to drink!
- Installation of the appliance should only be undertaken by a competent person, aware of the local codes in force. All plumbing and electrical connections must be done in accordance with local codes.
- Before setting up the appliance, make sure to check it for any externally visible damage; do not install or use when damaged.
- Use a hand truck to transport the appliance. To prevent accident or injury, do not hoist the appliance over your shoulder. Do not lay the appliance on its side.
- Keep this Technical Manual in a safe place and ensure that new users are familiar with the content.
- The appliance is designed and manufactured in accordance with current safety requirements and regulations. Incorrect repairs can result in unforeseen danger for the user, for which the manufacturer cannot be held responsible. Therefore repairs should only be undertaken by a competent technician, familiar and trained for this product.
- In respect of the environment, the appliance should be disposed of in accordance with Waste Electrical and Electronic Equipment requirements. Refer to national/local laws and codes for correct recycling of this appliance.

OPERATING CONDITIONS & REQUIREMENTS

- **OPERATING PRESSURE MIN-MAX: 2,0-8,3 bar / 29-120 psi**
 - check water pressure regularly; it may fluctuate severely depending on the time of day, the day of the week or even the season of the year.
 - take into account that night time water pressure may be considerably higher than day time water pressure.
 - install a pressure reducer ahead of the appliance if necessary.
 - install a pressure booster, if it is likely that water pressure may drop below the minimum.

- **OPERATING TEMPERATURE MIN-MAX: 2-48 °C / 36-120 °F**
 - do not install the appliance in an environment where high ambient temperatures (e.g. unvented boiler house) or freezing temperatures can occur.
 - the appliance cannot be exposed to outdoor elements, such as direct sunlight or atmospheric precipitation.
 - do not install the appliance too close to a water heater; keep at least 3 m (10 ft) of piping between the outlet of the appliance and the inlet of the water heater; water heaters can sometimes transmit heat back down the cold pipe into the appliance; always install a check valve at the outlet of the appliance.

- **ELECTRICAL CONNECTION:**
 - the appliance only works on 24 VDC; always use it in combination with the supplied transformer.
 - make sure to plug the transformer into a power outlet, which is installed in a dry location, with the proper rating and over-current protection.

INSTALLATION

INLET & OUTLET

We strongly recommend the use of flexible hoses to connect the appliance to the water distribution system; use hoses with a large diameter in order to limit the pressure loss.

If the appliance is not equipped with the factory bypass (optional), we strongly recommend to install a 3-valve bypass system (not included with this product!) to isolate the appliance from the water distribution system in case of repairs. It allows to turn off the water to the appliance, while maintaining (untreated) water supply to the user.

WITH FACTORY BYPASS (optional)

Picture 1

- ❶ = mains water supply (untreated water)
- ❷ = inlet of appliance (untreated water)
- ❸ = outlet of appliance (treated water)
- ❹ = house/application (treated water)

1. Screw the factory bypass onto the in/out ports on the control valve (❷&❸); make sure to install the gasket seals. Tighten the nuts firmly by hand.
2. Screw the connection kit with nuts onto the factory bypass (❶&❹); make sure to install the gasket seals. Tighten the nuts firmly by hand.
3. Connect the mains water supply to the adaptor on the inlet port of the factory bypass (❶).
4. Connect the house/application to the adaptor on the outlet port of the factory bypass (❹).

WITH 3-VALVE BYPASS SYSTEM (not included)

Picture 2

- ❶ = inlet of appliance (untreated water)
- ❷ = outlet of appliance (treated water)

1. Install the 3-valve bypass system.
2. Screw the connection kit with nuts onto the in/out ports on the control valve (❶&❷); make sure to install the gasket seals. Tighten the nuts firmly by hand.
3. Connect the 3-valve bypass system to the adaptors on the in (❶) and out (❷) port of the control valve.
4. Connect the mains water supply to the inlet of the 3-valve bypass system.
5. Connect the house/application to the outlet of the 3-valve bypass system.

DRAIN

We recommend the use of a stand pipe with P-trap.

To prevent backflow from the sewerage system into the appliance, always use a drain adaptor with air gap (optional), to connect the drain hose to the sewerage system.

Lay-out the drain hose in such a way that pressure loss is minimized; avoid kinks and unnecessary elevations.

Make sure that the sewerage system is suitable for the rinse water flow rate of the appliance.

Picture 3

1. Install a drain adaptor with air gap (optional) to the sewerage system; it fits over a 32 mm pipe or inside a 40 mm pipe adaptor. Ensure a permanent and watertight connection.
2. Connect a 13 mm hose (optional) to the drain connection of the control valve (❶); secure it by means of a clamp.
3. Run the drain hose to the drain adaptor and connect it to the drain adaptor; secure it by means of a clamp. This drain line operates under pressure, so it may be installed higher than the appliance.

COMMISSIONING

ELECTRICAL

Picture 4

1. Plug the transformers output lead into the socket on the control valves power cord; secure it by means of the TwistLock clamp.
2. Plug the transformer into an electrical outlet.

PRESSURIZING

1. Make sure the bypass system is in 'bypass' position.
2. Make sure the electronic controller of the appliance is in service mode.
3. Open the mains water supply.
4. Open a cold treated water faucet nearby the appliance and let the water run for a few minutes until all air is purged and all foreign material that may have resulted from the installation is washed out; close the tap.
5. Gently pressurize the appliance, by putting it into service:
 - *factory bypass:*
 1. open the 'outlet' valve;
 2. slowly open the 'inlet' valve.
 - *3-valve bypass:*
 1. close the 'bypass' valve;
 2. open the 'outlet' valve;
 3. slowly open the 'inlet' valve.
6. After 2-3 minutes, open a cold treated water faucet nearby the appliance and let the water run until all air is purged from the installation and the filter media is properly rinsed (it is normal for the rinse water to show some discoloration!); let the water run until the rinse water is clear; close the tap.
7. Check the appliance and all hydraulic connections for leaks.

ELECTRONIC CONTROL PANEL

1. Program the electronic controller.

PERFORM REGENERATION

1. Manually initiate a regeneration, by pressing the **scroll**  button. the display will show:

Regen in 10 sec

2. Leave the appliance in this position; the countdown timer will countdown to 0 sec and start a regeneration.

ELECTRONIC CONTROL PANEL

Picture 5

symbol	button	function
	SCROLL	to advance to the next parameter
	UP	to increase the value of the parameter
	DOWN	to decrease the value of the parameter

POWER-UP

After power-up the display will show the installed software version for a period of 5 seconds.

POWER FAILURE

In the event of a power failure, the program will remain stored in the NOVRAM® during an undefined period, while an incorporated SuperCap will maintain the correct time of day during a period of several hours; consequently, in case of prolonged power failure, the time of day might not be maintained; if this happens, the time of day will be reset to 8:00 when the power supply is re-established, while the indication will *flash*, indicating that the time of day needs to be set.

When the power failure occurs during the execution of an automatic regeneration, the control valve will remain in its last position; when the power supply is re-established, the control valve will return to the service position, stay there for 60 sec. and restart a complete regeneration from the beginning.

TIMER FAILURE

In the event of a timer failure, the display will show the message:

Service Required

The buzzer, if enabled (see Basic Settings), will beep continuously. If powering off/on the appliance doesn't solve this problem, professional service is required.

MAINTENANCE REMINDER

Only available if the maintenance reminder function has been activated and programmed by your supplier!

Once the maintenance interval is reached, the following will happen:

- the display will intermittently show the message:

**8:01 7 DAY REM
Maintenance Now**

- the buzzer, if enabled (see Basic Settings), will beep 3 times every hour.

While the appliance will continue to operate normally, it is recommended to have preventive maintenance performed by a professional.

To reset the maintenance reminder, simply access the configuration parameters programming mode.

SERVICE MODE

In **service mode** the display shows the time of day and the number of days remaining until the next regeneration:

8:01 7 DAY REM

REGENERATION MODE

In **regeneration mode** the display shows the remaining regeneration time and the remaining cycle time:

Rgn:XXX CycY:ZZZ

The appliance can be reset to service mode at any time by pressing the scroll button, as such manually advancing it through the regeneration cycles.

MANUAL REGENERATION

It is possible to manually initiate an immediate regeneration or a delayed regeneration (at the preprogrammed time of regeneration).

- Press the scroll button; the display will show:

Regen in 10 sec

- If the control panel is left in this position, the countdown timer will countdown to 0 sec and *start an immediate regeneration.*
- To cancel this mode, press the scroll button before the countdown timer has reached 0 sec; the display will show:

Regen @ 2:00

- If the control panel is left in this position, a *delayed regeneration will be started* at the indicated preprogrammed time of regeneration.
- To cancel this mode, press the scroll button; the control panel will return to the service mode.



HOLIDAY MODE

It is possible to put the appliance in holiday mode; this will prevent automatic regeneration from taking place, yet will ensure the appliance is automatically regenerated at the end of the holiday cycle.

ELECTRONIC CONTROL PANEL

1. Press the **scroll**  button repeatedly until the display shows:

Holiday: OFF

- Press the **up**  or **down**  button to activate the holiday mode by setting the number of **full days** away from home, or deactivate the holiday mode (OFF).

Once the control panel is back in service mode, the display will show:

8:01 Holiday



- The holiday mode is automatically cancelled when a regeneration is manually initiated!*

PROGRAMMING INSTRUCTIONS - BASIC SETTINGS

- Before entering the programming mode, make sure that the appliance is in service mode.*
- In case no button is pressed in a period of 5 min, the control panel will automatically return to the service mode; any changes made will NOT be saved!*

1. Press the **scroll**  button and hold it for 2 sec until the display shows:

Language: English

- Press the **up**  or **down**  button to set the language.

2. Press the **scroll**  button again; the display will show:

Set time: 8:01

- Press the **up**  or **down**  button to set the time of day.

3. Press the **scroll**  button again; the display will show:

Interval: 7 Days

- Press the **up**  or **down**  button to set the number of days between regenerations.

4. Press the **scroll**  button again; the display will show:

Buzzer: ON

- Press the **up**  or **down**  button to enable or disable the buzzer.

5. Press the **scroll**  button again; the display will show:

Exit

- Press the **up**  or **down**  button to save the settings into the NOVRAM® and exit the programming mode.

- The regeneration cycle is necessary to wash out impurities that are captured in the filter media during the service cycle, and to prevent 'caking' of the filter media, which may result in an increase of pressure drop over the appliance. Typically a regeneration every 7 days should be sufficient. In case of high flow rates, excessive water usage or a high concentration of impurities in the incoming water, it may be necessary to lower the number of days between regenerations.*

ELECTRONIC CONTROL PANEL

PROGRAMMING INSTRUCTIONS CONFIGURATION PARAMETERS



- Before entering the programming mode, make sure that the appliance is in service mode.
- All configuration parameters on this appliance have been pre-programmed in the factory, to offer optimal performance in a wide range of applications and situations. Nevertheless it may be necessary or desirable to change any of these parameters, to further optimize the appliances performance or to adapt it to the specific requirements of the installation.
- In case no button is pressed in a period of 5 min, the control panel will automatically return to the service mode; any changes made will NOT be saved!

1. Press the **scroll**  button and hold it for 6 sec until the display shows:

System Check



2. Within 10 sec, press the **up**  button; the display will show:

Units:Metric

- Press the **up**  or **down**  button to set the units of measure (Metric or US).



3. Press the **scroll**  button again; the display will show:

MaintInt: 24mths

- Press the **up**  or **down**  button to activate the maintenance reminder function by setting the maintenance interval, or deactivate the maintenance reminder function.

4. Press the **scroll**  button again; the display will show:

Cycle 1: XX min

- Press the **up**  or **down**  button to set the length of the regeneration cycle.
- Press the **scroll**  button again to advance to the next regeneration cycle.

Cycle 1	Backwash
Cycle 2	No function
Cycle 3	Fast rinse



5. Press the **scroll**  button again; the display will show:

Regen @ 0:00

- Press the **up**  or **down**  button to set the time of regeneration.

6. Press the **scroll**  button again; the display will show:

Exit

- Press the **up**  or **down**  button to save the settings into the NOVRAM® and exit the programming mode.

ELECTRONIC CONTROL PANEL

DIAGNOSTICS MODE

- ☑ *In the Diagnostics mode several operating parameters can be consulted; particularly during a service intervention, these parameters can be helpful to identify the cause of a problem or malfunction.*
- ☑ *Before entering the Diagnostics mode, make sure that the appliance is in service mode.*
- ☑ *In case no button is pressed in a period of 5 min, the control panel will automatically return to the service mode!*

Accessing the Diagnostics mode

1. Press the **scroll** ⤴ button and hold it for 6 sec until the display shows:

System Check

2. Within 10 sec, press the **down** ⬇ button; the display will show:

Regen XXdays ago

- You are now in the Diagnostics mode.
- Press the **scroll** ⤴ button to advance to the next diagnostics parameter.

Available diagnostics parameters

- **Regen X days ago**: number of days since last regeneration.
- **In Srvc**: total number of days in service.
- **# of Regens**: number of regenerations since installation.
- **Regen @**: setting of time of regeneration.
- **Interval**: setting of number of days between regenerations.
- **Cycle X**: setting of length of corresponding regeneration cycle.
- **Units**: control is programmed for Metric units.
- **Regen**: setting of the regeneration mode.
- **Valve Type**: setting of valve type.
- **MP Resets**: number of resets of microprocessor (*for factory purpose only*).
- **Memory Reset**: number of corrupt memory start-ups (*for factory purpose only*).
- **EZRFTg EZDRV r02**: software version.

Exiting the Diagnostics mode

1. Press the **scroll** ⤴ button repeatedly until the display shows:

Exit

- Press the **up** ⬆ or **down** ⬇ button to exit the Diagnostics mode.

MAINTENANCE

RECOMMENDATION

Notwithstanding the reliability of the appliance, we strongly recommend to have it serviced and maintained on a regular basis by a competent and duly trained technician. He will be able to determine the appropriate maintenance interval for the appliance, depending on your specific application and the local operating conditions. The advantages of performing regular maintenance are:

- regular check of the local operating conditions (water quality, pressure, etc);
- regular control and adjustment of the settings of the appliance, to guarantee it operates at maximum efficiency;
- minimize the risk of unexpected break-down.

Contact your dealer or installer for more information, or visit our website.

ROUTINE CHECKS

Regularly the user should perform a basic check to verify if the appliance is functioning correctly, on the basis of the following control points:

1. Check settings of electronic control panel.
2. Check water composition before/after appliance.
3. Check drain line from control valve; there shouldn't be any water flow (unless appliance is in regeneration).
4. Check appliance and surrounding area; there shouldn't be any water leakages.

BYPASSING THE APPLIANCE

Occasionally it may be necessary to put the appliance hydraulically in bypass, i.e. to isolate it from the water distribution system; f.e.:

- in case of an urgent technical problem;
- when it is not necessary to supply treated water to the house/application (refill swimming pool, irrigation,...).

WITH FACTORY BYPASS (optional)

Picture 6.a

SERVICE POSITION

- ❶ = inlet valve to appliance is OPEN
- ❷ = outlet valve from appliance is OPEN

Picture 6.b

BYPASS POSITION

- ❶ = inlet valve to appliance is CLOSED
- ❷ = outlet valve from appliance is CLOSED

Picture 6.c

MAINTENANCE POSITION

- ❶ = inlet valve to appliance is OPEN
- ❷ = outlet valve from appliance is CLOSED

WITH 3-VALVE BYPASS SYSTEM (not included)

Picture 7.a

SERVICE POSITION

- ❶ = bypass valve is CLOSED
- ❷ = inlet valve to appliance is OPEN
- ❸ = outlet valve from appliance is OPEN

Picture 7.b

BYPASS POSITION

- ❶ = bypass valve is OPEN
- ❷ = inlet valve to appliance is CLOSED
- ❸ = outlet valve from appliance is CLOSED

Picture 7.c

MAINTENANCE POSITION

- ❶ = bypass valve is OPEN
- ❷ = inlet valve to appliance is OPEN
- ❸ = outlet valve from appliance is CLOSED

SANITIZING THE APPLIANCE

This appliance is manufactured from premium quality material and assembled in safe conditions to assure it is clean and sanitary. If installed and serviced correctly, this appliance will not infect or contaminate your water supply. However, as in any 'device' plumbed-in in your water distribution system, a proliferation of bacteria is possible, especially in case of 'stagnant water'. Therefore this appliance will automatically rinse the filter media periodically.

If the power supply to the appliance is disconnected for a longer period of time, we recommend, when the power supply is re-established, to manually initiate a complete regeneration.

TROUBLESHOOTING

PROBLEM	CAUSE	SOLUTION
Untreated water to service	Open or defective bypass	Close or replace bypass
	Appliance in regeneration	Wait until regeneration finishes or manually advance regeneration to end
	Excessive water usage	Initiate regeneration manually
	Change in raw water hardness	Verify composition of incoming untreated water and adjust regeneration frequency accordingly
	Appliance fails to regenerate	Refer to problem "Appliance fails to regenerate"
	Appliance fails to backwash properly	Refer to problem "Appliance fails to backwash properly"
	Valve body and timer out of synchronisation	Synchronize valve body and timer
	Decreasing filter capacity of filter media	Clean or replace filter media
	Loss of filter media	Refer to problem "Loss of filter media"
Leak at riser tube	Verify that riser tube is seated correctly and is not cracked	
Low levels of contaminant in treated water	Bypass not completely closed	Close bypass
	Excessive service flow rate	Lower service flow rate Increase filter capacity by increasing volume of filter media
	Leak at riser tube	Verify that riser tube is seated correctly and is not cracked
Appliance fails to regenerate	Faulty electrical supply	Verify electrical service (fuse, transformer,...)
	Defective PCB	Replace PCB
	Defective drive motor	Replace drive motor
	Regeneration frequency not programmed	Program regeneration frequency
Loss of water pressure	Mineral or iron build-up in resin tank	Clean resin bed and control valve; increase regeneration frequency
	Plugged lower and/or upper distributor	Verify that distributors are free of debris
	Crushed lower and/or upper distributor	Replace distributor(s)
Drain line from control valve flows continuously	Appliance in regeneration	Wait until regeneration finishes or manually advance regeneration to end
	Faulty electrical supply	Verify electrical service (fuse, transformer,...)
	Defective drive motor	Replace drive motor
	Defective micro switch	Replace micro switches
	Defective PCB	Replace PCB
	Valve body and timer out of synchronisation	Synchronize valve body and timer
Loss of filter media	Lower and/or upper distributor damaged	Replace distributor(s)
	Leak between riser tube and upper distributor	Verify that riser tube is seated correctly and is not cracked
Appliance fails to backwash properly	Low operating pressure	Check operating pressure; must be higher than 2,0 bar
	Insufficient water supply	Check water supply (flow rate/dynamic pressure)
	Restricted drain line	Verify drain line for kinks or restrictions
	Excessive build-up of impurities in pressure tank	Clean or replace filter media and control valve; increase regeneration frequency
	Plugged backwash flow control	Clean or replace backwash flow control
	Plugged top or bottom distributor	Verify that top and bottom distributor are clean and slots are not clogged by iron or other impurities
	Filter media is completely 'caked' (solid block)	Replace filter media and reduce regeneration interval
Control valve cycles continuously	Defective micro switch	Replace micro switches

ELECTRICAL WIRING DIAGRAM

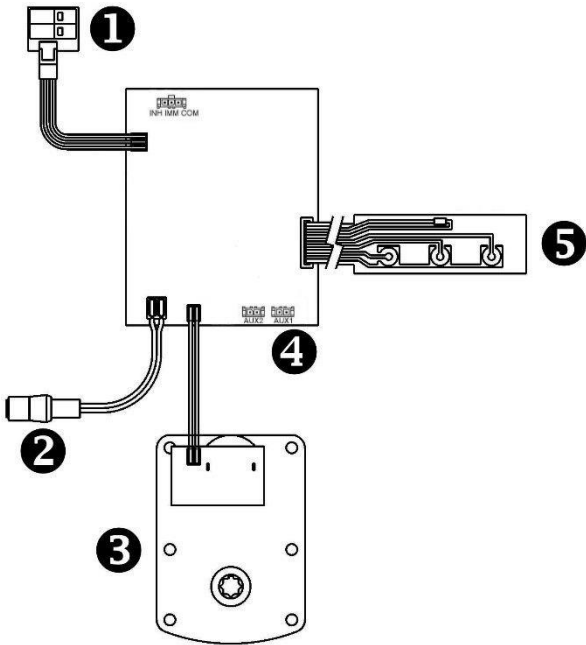

- ❶ = position switches
- ❷ = power lead
- ❸ = drive motor
- ❹ = auxilliary contacts (2 x 24 VDC, max. 500mA)
- ❺ = key pad

DEFAULT CONFIGURATION PARAMETER SETTINGS

Model	IQsoft-WHF-		
Filter media	12	26	44
Units	Metric	Metric	Metric
MaintInt (mths)	24	24	24
Cycle 1: BACKWASH (min)	5	5	5
Cycle 2: SLOW RINSE (min)	0	0	0
Cycle 3: PURGE (min)	2	2	2
Regen @	0:00	0:00	0:00

EXPLODED VIEW - SYSTEM

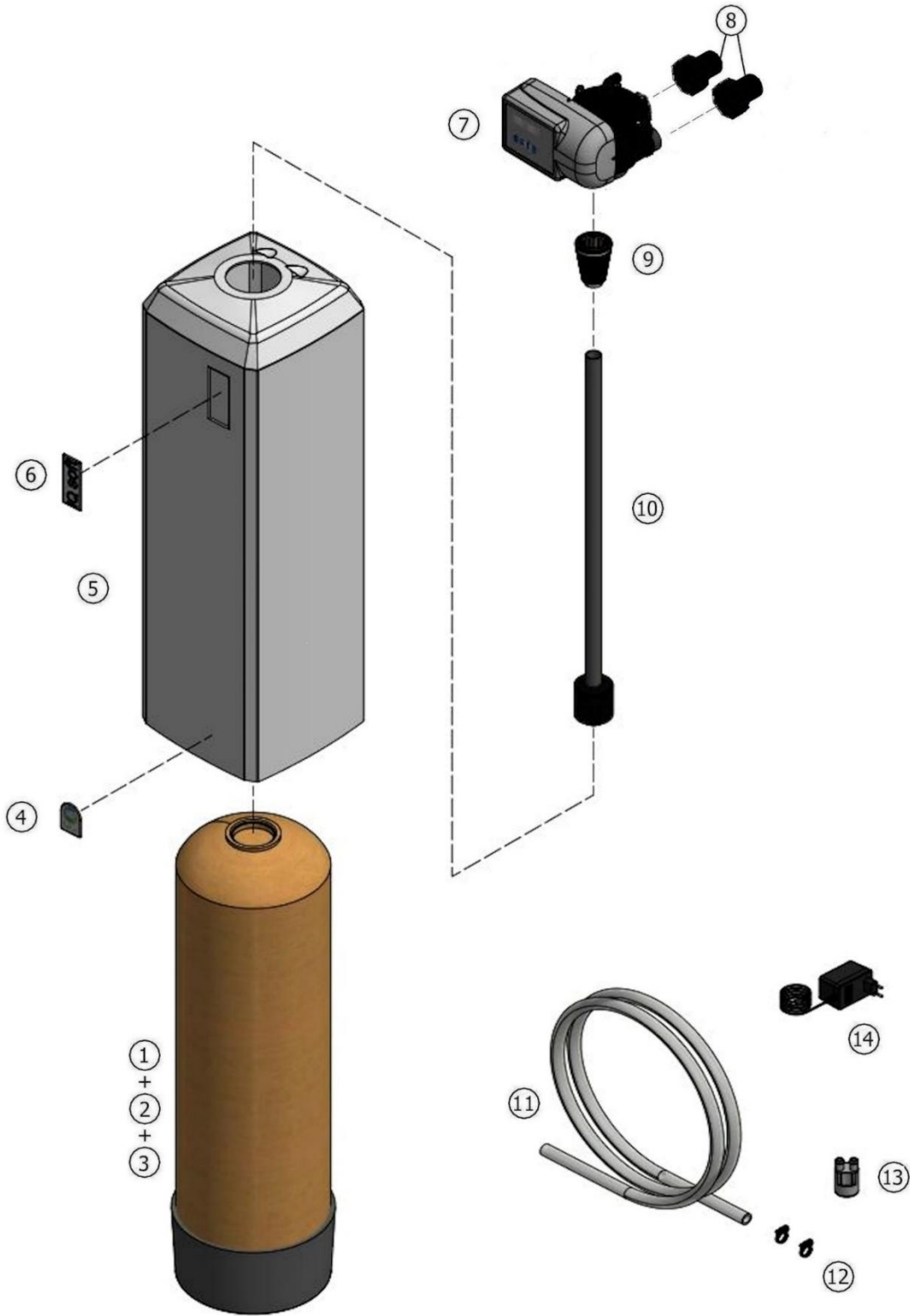

EXPLODED VIEW - SYSTEM

Item	PN	Description	Remark	(*)
1	PT/1018/BA(GR)	Pressure tank, 10x18	12L	✓
	PT/1035/BA(GR)	Pressure tank, 10x35	26L	✓
	PT/1054/BA(GR)	Pressure tank, 10x54	44L	✓
2	A1100(BB)	Coconut Granular Activated Carbon (GAC)	multiple of 1 cuft	✓
3	A1000	Gravel	multiple of 25 kg (=17 ltr)	
4	39004	Dome label 'erie water treatment'		
5	39125	Cabinet IQsoft, Mini	12L	
	39126	Cabinet IQsoft, Midi	26L	
	39127	Cabinet IQsoft, Maxi	44L	
6	39013	Dome label 'IQsoft'		
7	2400TF/JM/AUX/IQS-W	Control valve with Wi-Fi		✓
8	568/303/1	Connection kit 1" BSP male		
9	287/166/LS	Top distributor		✓
10	38534	Riser tube assembly	to be cut to length, 20mm below pressure tank opening	✓
11	74143	Drain hose	3 mtr	
	74170		5 mtr	
12	38521	Clamp, drain hose (2x)		
13	74163	Air gap with double hose barb		
14	74312	Transformer 100-230/24 VDC - 50Hz, 24VA, EuroT plug		✓

(*) Recommended Spare Part

EXPLODED VIEW - TIMER ASSEMBLY

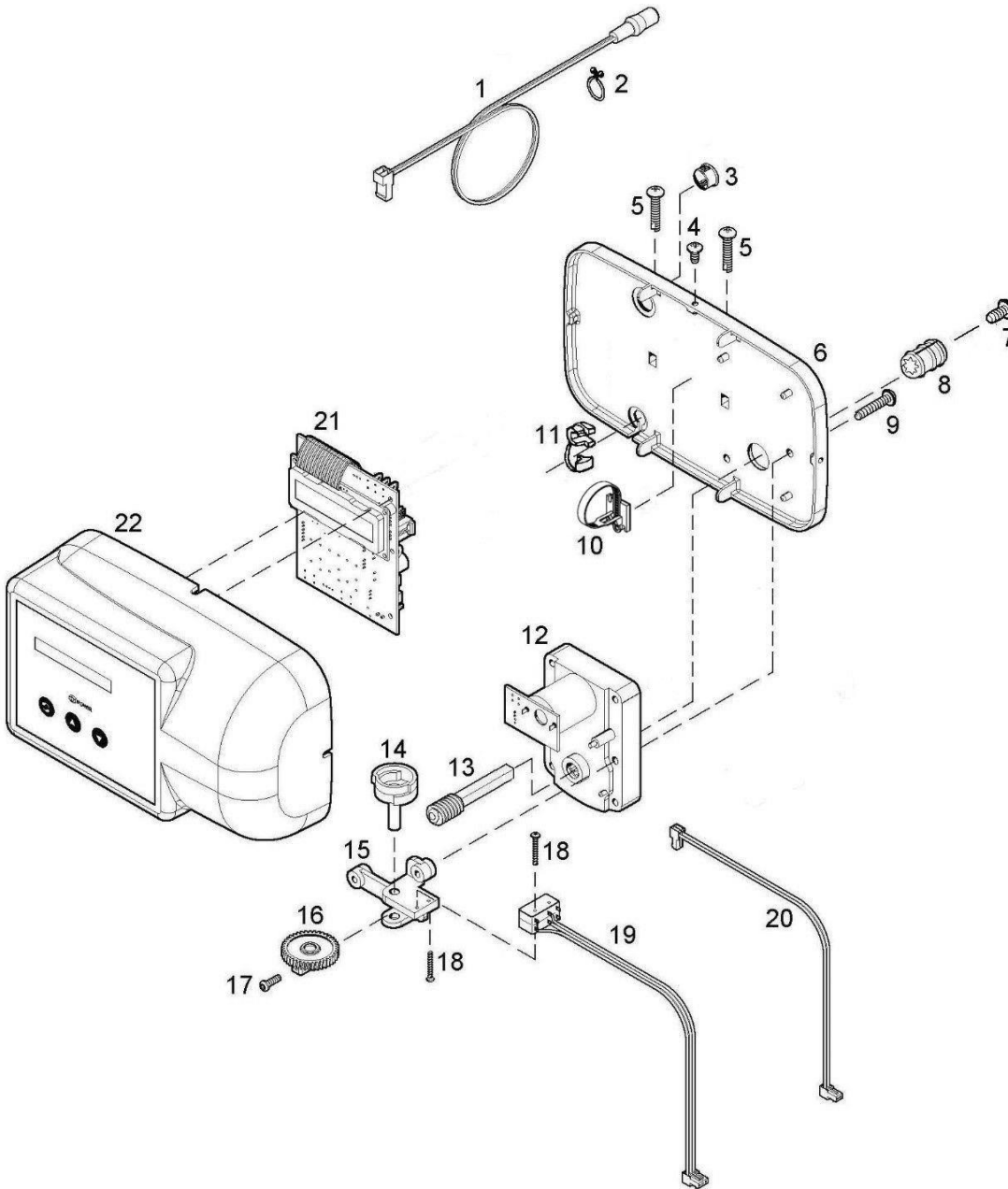

EXPLODED VIEW - TIMER ASSEMBLY

Item	PN	Description	Remark	(*)
1	74307	Power lead with plug		✓
2	72263	Clamp		
3	28/244/1	Plug (large)		
4	71502	Screw, timer cover (3x)		
5	15/222	Screw, back plate (2x)		
6	70962	Back plate		
7	15/102	Screw, worm coupling	Incl. in repair kit A	
8	75157	Worm coupling	Incl. in repair kit A	✓
9	15/222	Screw, drive motor assembly (2x)		
10	74267	Cable clamp		
11	70312	Strain relief, power lead		
12	72261	Drive motor		✓
13	75156	Worm drive shaft	Incl. in repair kit A	✓
14	70965	Switch cam		
15	568/386	Bracket, micro switches		
16	568/310	Gear, switch cam		
17	15/184/7	Locking screw, switch cam		
18	15/173/12	Screw, micro switches (2x)		
19	72451	Micro switch assy		✓
20	71679	Cable set, drive motor		✓
21	74411	Printed Circuit Board with Wi-Fi - 24 VDC		✓
22	74366	Timer cover assembly 'IQsoft'		
A	RK/75157	Repair kit worm coupling and worm drive shaft		✓

(*) Recommended Spare Part

EXPLODED VIEW - VALVE BODY

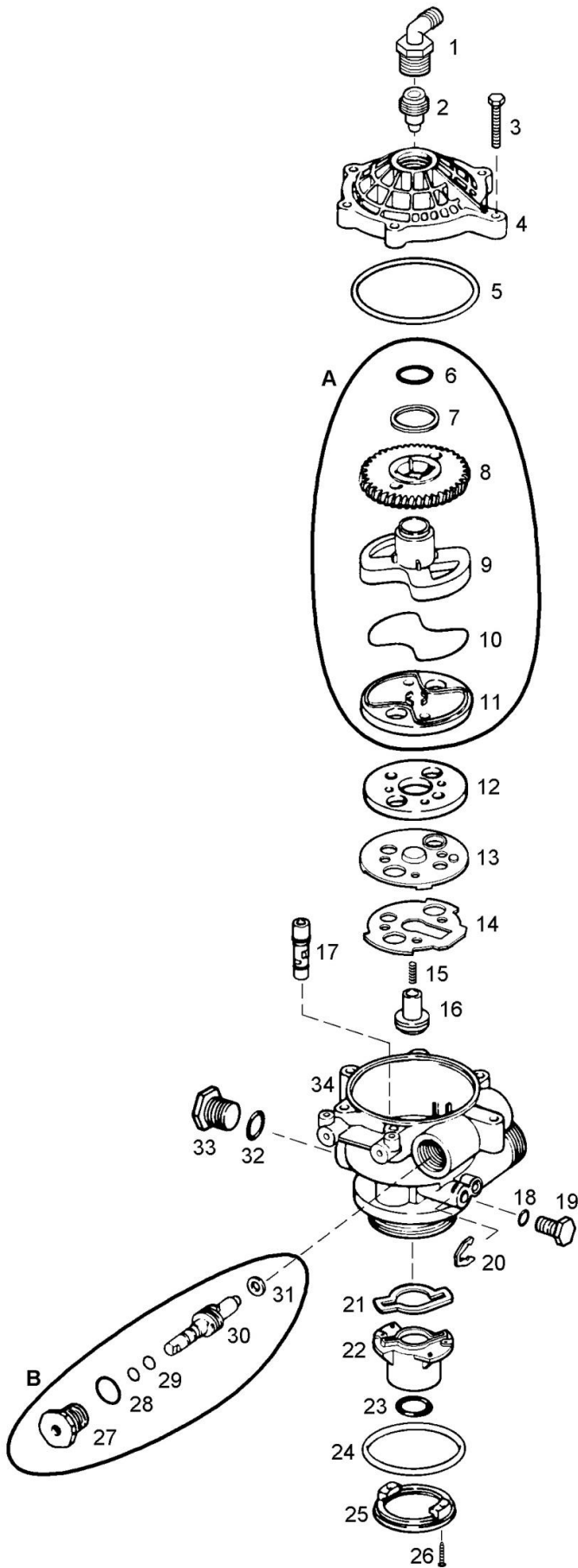

EXPLODED VIEW - VALVE BODY

Item	PN	Description	Remark	(*)
1	21/83	Drain connection		
2	568/271/M	Backwash flow control M (18,9 ltr/min)		
3	72678	Bolt, valve cover (6x)		
4	568/254/3	Valve cover		
5	185/154/1	O-ring, valve cover		
6	186/112	O-ring, Teflon		
7	72327	Washer, PE		
8	568/260	Worm gear		
9	568/259	Rotor cam		
10	185/041/1	O-ring, rotor		
11	568/345/2	Rotor plate		✓
12	568/256	Seal disk		✓
13	568/383	Insert plate		
14	568/384	Gasket		
15	51/5/105	Spring, float valve		
16	568/270/4	Float valve		
17	568/274/5	Injector (green)		
18	186/118	O-ring, plug (small)		
19	541/273	Plug (small)		
20	541/254	Spring clip, plug (small)		
21	570/251	Gasket, riser		
22	568/334	Riser insert		
23	185/214/1	O-ring, riser tube		
24	185/337/1	O-ring, tank		
25	541/232	Adapter ring		
26	15/207/12	Screw, adapter ring (2x)		
27	72772	Packing gland nut (plastic)		
28	185/211/1	O-ring, packing gland nut		
29	186/115	O-ring, worm drive shaft (2x)		
30	568/208/2	Worm drive shaft		
31	14/43	Washer, worm drive shaft		
32	185/208/1	O-ring, plug (large)		
33	21/72/3	Plug (large)		
34	72800	Valve body		
A	RK/568/259/2	Repair kit rotor		✓
B	RK/75154	Repair kit packing gland nut		

(*) Recommended Spare Part

TECHNICAL DATA

Technical specifications:

Model	IQsoft-WHF-		
	12	26	44
Filter media (Ltr)			
Operating pressure min/max (bar)	2,0/8,3		
Operating temperature min/max (°C)	2/48		
Electrical connection (V/Hz)	230/50 ⁽¹⁾		
Max. power consumption (VA)	8		
Hydraulic connection inlet/outlet	1" BSP Male		
Hydraulic connection drain	13 mm hose barb		
Pressure tank	10x18	10x35	10x54

(1) Supplied with 24 VDC transformer

Performances @ 3 bar operating pressure⁽²⁾:

Model	IQsoft-WHF-		
	12	26	44
Filter media (Ltr)			
Service flow rate @ Δp 1 bar (m ³ /hr) ⁽³⁾	3,6	3,4	3,2
Recomm. max. service flow (m ³ /hr) ⁽⁴⁾	1,0	1,2	1,4
Rinse water usage per regeneration (ltr)	132	132	132
Backwash flow rate (ltr/min)	19	19	19

(2) Indicative numbers, performances depending on operating conditions and water quality

(3) Based on clean filter bed operation

(4) Flow rate at which filtration process is still executed adequately, higher (up to x2) intermittent flow rates are possible

Dimensions:

Model	IQsoft-WHF-		
	12	26	44
Filter media (Ltr)			
Width (mm) (W)	264	264	264
Depth (mm) (D)	282	282	282
Depth, incl. factory bypass (mm) (D)	371	371	371
Height (mm) (H)	629	1.065	1.554

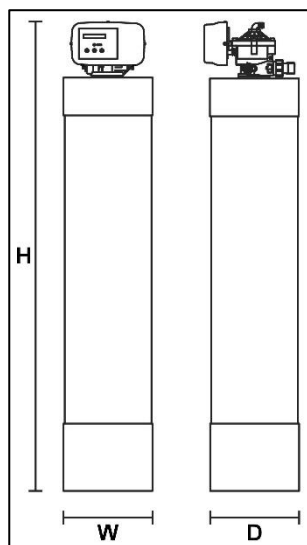







erie water treatment

a division of **Aquion, Inc.**

www.eriewaterreatment.com